

Differential pressure transmitter

0 ... 0.1 – 25 bar



 **Huba Control**

FEINE MESSIDEEN FÜR DRUCK UND STRÖMUNG
FOR FINE PRESSURE AND FLOW MEASUREMENT
LA FINESSE DES MESURES DE PRESSION ET DE DEBIT

Technical overview

The differential pressure transmitter of type series 692 with proven, unique ceramic technology, features adjusted and amplified sensor signals which are available as standardised voltage or current outputs.

Various application-specific pressure and electrical connections and housing materials suitable for different media can be provided.

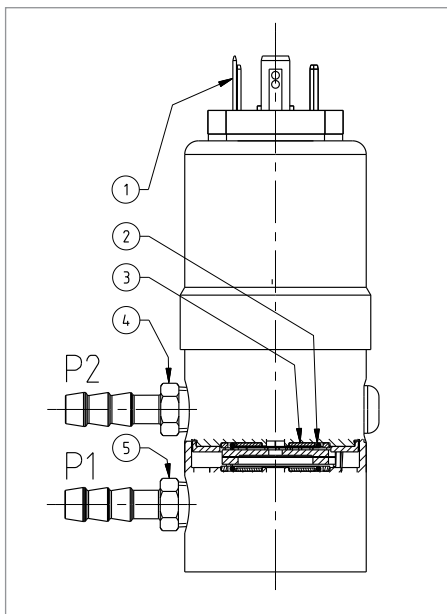

Legend to cross-section drawing

- 1 Electrical connection
- 2 Seals
- 3 Ceramic element
- 4 P2 Pressure connection (lower pressure)
- 5 P1 Pressure connection (higher pressure)

The distinct advantages

- Very low temperature sensitivity
- High resistance to extreme temperatures
- No mechanical creepage
- Modular system and choice of materials to suit individual applications

Medium

Liquids and neutral gases

Pressure ranges

0 ... 0.1 – 25 bar

Tolerable overload on one side

See order code selection table

System pressure

25 bar on differential pressure range ≤ 6 bar
50 bar on differential pressure range ≥ 10 bar

Rupture pressure

1.5 x system pressure

Setting range

(Only adjustable versions)
Zero point and full scale $\pm 10\%$ fs

Materials in contact with the medium

Pressure connection:
Stainless steel 1.4305 / AISI 303, PVDF, CuZn vni
Diaphragm: Ceramic Al_2O_3 (96%)
Sealing material: FPM, EPDM, NBR, MVQ

Case material

Stainless steel 1.4305 / AISI 303

Temperature

Medium and ambient $-15 \dots +85$ °C
Storage $-40 \dots +85$ °C

Output

3-wire
0 ... 5 VDC
0 ... 10 VDC

Power supply

11 ... 33 VDC
24 VAC $\pm 15\%$
18 ... 33 VDC
24 VAC $\pm 15\%$

2-wire
4 ... 20 mA

11 ... 33 VDC

Load

3-wire > 10 kOhm
2-wire $\leq \frac{\text{supply voltage} - 11 \text{ V}}{0.02 \text{ A}}$ [Ohm]

Current consumption

At nominal pressure
3-wire < 5 mA
2-wire < 20 mA

Dynamic response

Suitable for static and dynamic measurements

Response time < 5 ms
Load cycle < 50 Hz

Electrical connection

Connector DIN EN 175301-803-A
Round connector DIN EN 60130-9
Cable 1.5 m

Polarity reversal protection

Short circuit proof and protected against polarity reversal. Each connection is protected against crossover up to max. supply voltage.

Protection standard

IP 65

Pressure connections

Pressure-tube tip $\varnothing 4$ mm / 6 mm
Screw fitting $\varnothing 6$ mm / 8 mm
Outside thread 7/16-20 UNF, G1/8
Inside thread 1/8-27 NPT, G1/8

Installation arrangement

Unrestricted

Mounting

Mounting bracket

Tests / Admissions

CE conformity

Weight

Approx. 430 g

Packaging

Single packaging
in cardboard, accessories included

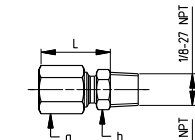
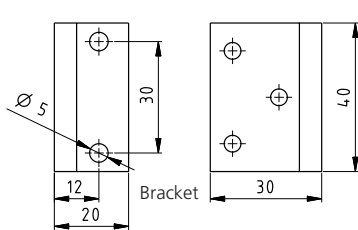
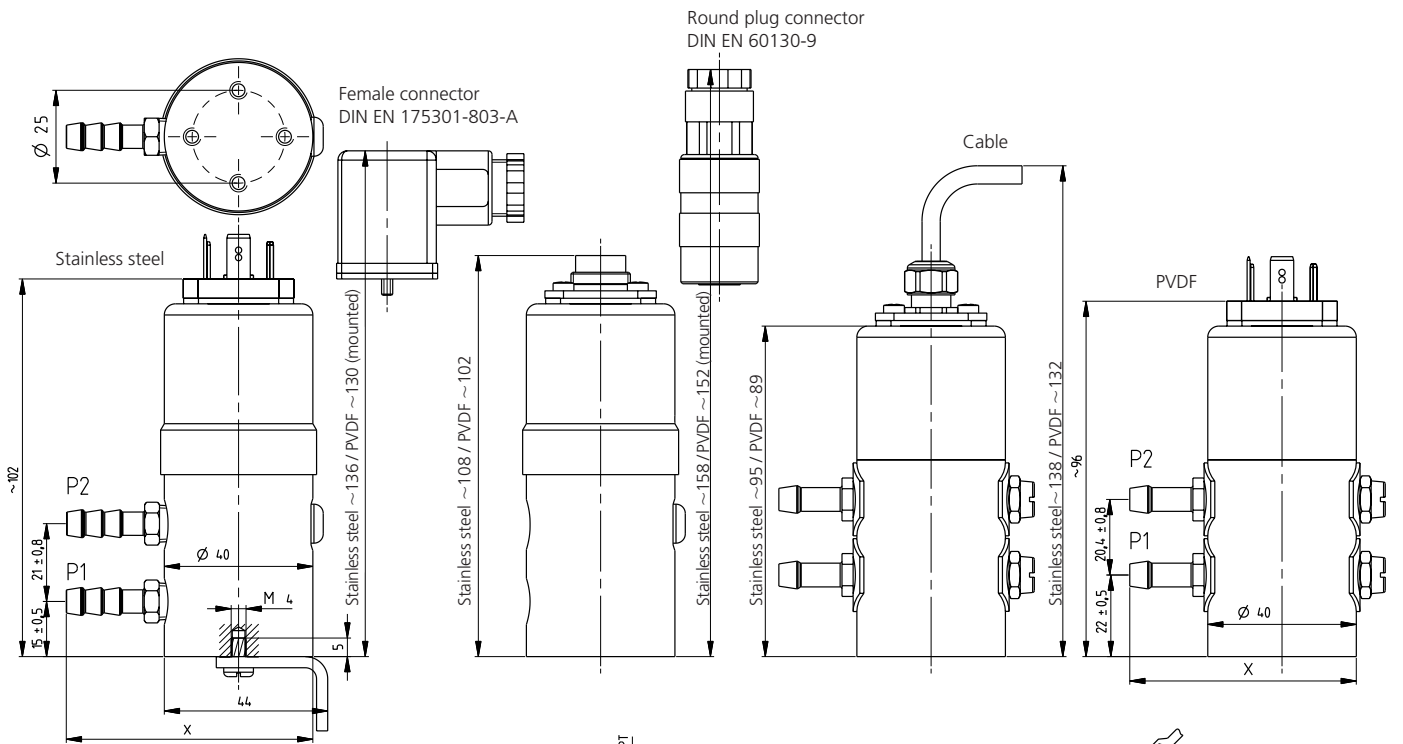

Stainless steel 1.4305 AISI 303	Screw fitting for pipe outside Ø 6	a = 10	L ~24	X ~65
	Screw fitting for pipe outside Ø 8	b = 12	L ~26	X ~67

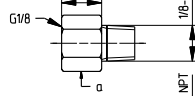

Stainless steel 1.4305 AISI 303	Inside thread G1/8	a = 14	L ~12	X ~53
---------------------------------------	--------------------	--------	-------	-------

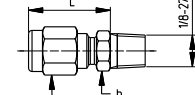

CuZn vni	Screw fitting for pipe outside Ø 6	a = 10	L ~24	X ~65
	Screw fitting for pipe outside Ø 8	b = 12	L ~25	X ~66

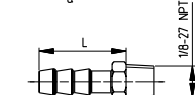

CuZn vni Stainless steel 1.4571 AISI 316Ti	Hose connection for tube Ø 4	a = 10	L ~20	X ~61
	Hose connection for tube Ø 6	b = 10	L ~25	X ~66

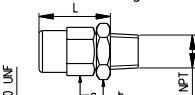

CuZn vni	Outside thread G1/8	a = 10	L ~20	X ~61
		b = 12		

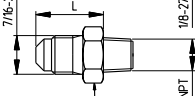

CuZn vni	Outside thread 7/16-20 UNF	a = 14	L ~18	X ~59
----------	----------------------------	--------	-------	-------

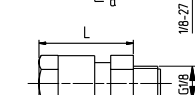

PVDF	Pressure fitting for pipe outside Ø 6	a = 12	L ~20	X ~61
	Pressure fitting for pipe outside Ø 8	b = 14	L ~23	X ~64



PVDF	Hose connection for tube Ø 6	a = 10	L ~20	X ~61
------	------------------------------	--------	-------	-------

2-wire

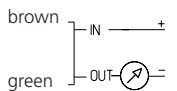

3-wire

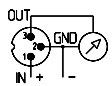
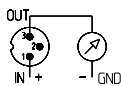
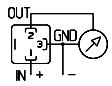
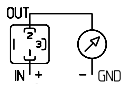
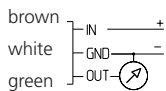

Electromagnetic compatibility

CE conformity (EMC) by application of harmonised standards: Interference stability EN 61000-6-2 and EN 61000-6-3, Interference emit EN 61000-6-3 and EN 61326-1

Interference stability	Test standard	Effect
Electrostatic discharge (ESD)	EN 61000-4-2	8 kV air, 4 kV contact
High-frequency electromagnetic radiation (HF)	EN 61000-4-3	10 V/m, 80 ... 1000 MHz
Conducted HF interference	EN 61000-4-6	10 V, 0.15 ... 80 MHz
Fast transients (burst)	EN 61000-4-4	2 kV
Surge	EN 61000-4-5	max. tolerable cable length 10 m
Magnetic fields	EN 61000-4-8	30 A/m, 50 Hz
Interference emit		
Conducted interference	EN 55022 (CISPR 22)	0.15 ... 30 MHz
Radiation from housing		30 ... 1000 MHz, 10 m

Headquarters

Huba Control Schweiz

Industriestrasse 17
CH-5436 Würenlos
Telefon ++41 (0) 56 436 82 00
Telefax ++41 (0) 56 436 82 82
info.ch@hubacontrol.com

Huba Control Deutschland

Schlattgrabenstrasse 24
72141 Walddorfhäslach
Telefon (07127) 23 93-00
Telefax (07127) 23 93-20
info.de@hubacontrol.com

Huba Control France

Technopôle Forbach-Sud
57602 Forbach Cedex
Téléphone 03 87 84 73 00
Télécopieur 03 87 84 73 01
info.fr@hubacontrol.com

Huba Control Nederland

Hamseweg 20A
3828 AD Hoogland
Telefoon 033 433 03 66
Telefax 033 433 03 77
info.nl@hubacontrol.com

Huba Control United Kingdom

Unit 3 Network Point, Range Road
Witney Oxfordshire OX29 0YD
Phone 01993 776667
Fax 01993 776671
info.uk@hubacontrol.com

www.hubacontrol.com

**Huba Control**

FEINE MESSIDEEN FÜR DRUCK UND STRÖMUNG
FOR FINE PRESSURE AND FLOW MEASUREMENT
LA FINESSE DES MESURES DE PRESSION ET DE DEBIT